

AC-825IP

Networked Controller

Hardware Installation and User Guide



ROSSLARE
SECURITY PRODUCTS

Copyright © 2020 by Rosslare. All rights reserved.

This manual and the information contained herein are proprietary to ROSSLARE ENTERPRISES LIMITED and/or its related companies and/or subsidiaries' (hereafter: "ROSSLARE"). Only ROSSLARE and its customers have the right to use the information.

No part of this manual may be re-produced or transmitted in any form or by any means, electronic or mechanical, for any purpose, without the express written permission of ROSSLARE.

ROSSLARE owns patents and patent applications, trademarks, copyrights, or other intellectual property rights covering the subject matter in this manual.

TEXTS, IMAGES, AND ILLUSTRATIONS INCLUDING THEIR ARRANGEMENT IN THIS DOCUMENT ARE SUBJECT TO THE PROTECTION OF COPYRIGHT LAWS AND OTHER LEGAL RIGHTS WORLDWIDE. THEIR USE, REPRODUCTION, AND TRANSMITTAL TO THIRD PARTIES WITHOUT EXPRESS WRITTEN PERMISSION MAY RESULT IN LEGAL PROCEEDINGS.

The furnishing of this manual to any party does not give that party or any third party any license to these patents, trademarks, copyrights or other intellectual property rights, except as expressly provided in any written agreement of ROSSLARE.

ROSSLARE reserves the right to revise and change this document at any time, without being obliged to announce such revisions or changes beforehand or after the fact.

Table of Contents

1. Introduction	8
1.1 Open Supervised Device Protocol	9
1.2 AxTraxNG	9
1.2.1 Client-Server Structure	9
1.2.2 Configurable Links	10
1.3 Compatible Readers	10
2. Technical Specifications	11
2.1 ME-1515 Enclosure	11
2.2 Expansions for AC-825IP	12
3. AC-825IP Panel Setup	13
3.1 Mounting	14
3.1.1 Mounting the ME-1515 Enclosure	14
3.1.2 Connecting the Pull-Safe™ Cable Locks	16
3.1.3 Mounting using the DIN Rail	17
3.2 Input Wiring – Supervised Inputs	20
3.3 Output Wiring	21
3.4 Power Management	23
3.5 AC-825IP Wiring Ports	24
3.6 R/S/D/P-805 Extension Board Setup	25
3.6.1 Daisy Chain System	26
3.6.2 DIP Switching	27
3.7 Readers and Cable Length	29
4. Input and Output Connections	31
4.1 Input Types	31
4.1.1 Normally Open Input Connection	31
4.1.2 Normally Closed Input Connection	31
4.1.3 Normally Open Supervised Single EOL Resistor Input Connection	32
4.1.4 Normally Open Supervised Double EOL Resistor Input Connection	32

Table of Contents

4.1.5	Normally Closed Supervised Single EOL Resistor Input Connection.....	33
4.1.6	Normally Closed Supervised Double EOL Resistor Input Connection.....	33
4.2	Inputs Description.....	34
4.2.1	Request-to-Exit Button (REX) Input.....	34
4.2.2	Door Monitor Input.....	34
4.2.3	General Purpose Inputs.....	35
4.3	Outputs.....	36
4.3.1	Door Lock.....	36
4.4	Card Readers and Keypads.....	37
5.	AC-825IP Hardware Settings.....	39
5.1	DIP Switch Configuration.....	42
5.2	Setting AC-825IP Panel Type in AxTraxNG.....	42
6.	Communications.....	43
6.1	TCP/IP Network Connection.....	43
6.1.1	LAN and WAN Requirements.....	43
A.	Limited Warranty.....	45

List of Figures

Figure 1: Sample AC-825IP Configuration.....	13
Figure 2: ME-1515 Drill Holes.....	14
Figure 3: C14 Socket.....	15
Figure 4: Location of the Maximum Power Rating Sticker.....	15
Figure 5: Attaching the Pull-Safe Cable Locks	16
Figure 6: DIN Rail	17
Figure 7: Unlocking the DIN Rail Handle.....	17
Figure 8: Positioning the Panels	18
Figure 9: Adding a Screw as a Stopper	18
Figure 10: DIN Rail Dimensions (Top View).....	19
Figure 11: Input Wiring – Supervised Inputs.....	20
Figure 12: Door Lock – Failed Close	21
Figure 13: Door Lock – Failed Open	22
Figure 14: AC-825IP in the ME-1515 Enclosure.....	23
Figure 15: AC-825IP Wiring Communications.....	24
Figure 16: Slot for Expansion Board Attachment.....	25
Figure 17: Daisy Chain Setup.....	26
Figure 18: OSDP/RSDP Bus on AC-825IP Panel.....	26
Figure 19: RSDP Bus on Expansion Board.....	26
Figure 20: Termination with Resistor.....	27
Figure 21: Reader Wiring – Wiegand	29
Figure 22: Reader Wiring – OSDP	29
Figure 23: Normally Open Input Connection.....	31
Figure 24: Normally Closed Input Connection.....	32
Figure 25: Normally Open Supervised Input (Single Resistor).....	32
Figure 26: Normally Open Supervised Input (Double Resistor).....	33
Figure 27: Normally Closed Supervised Input (Single Resistor).....	33
Figure 28: Normally Closed Supervised Input (Double Resistor).....	34
Figure 29: Connecting Multiple AC-825IP Panels to the AxTraxNG Server.....	43

List of Tables

Table 1: Serial Address and DIP Switch Combinations	27
Table 2: Possible Hardware Settings.....	39

Notice and Disclaimer

This manual's sole purpose is to assist installers and/or users in the safe and efficient installation and usage of the system and/or product, and/or software described herein.

BEFORE ATTEMPTING TO INSTALL AND/OR USE THE SYSTEM, THE INSTALLER AND THE USER MUST READ THIS MANUAL AND BECOME FAMILIAR WITH ALL SAFETY REQUIREMENTS AND OPERATING PROCEDURES.

- The system must not be used for purposes other than those for which it was designed.
- The use of the software associated with the system and/or product, if applicable, is subject to the terms of the license provided as part of the purchase documents.
- ROSSLARE ENTERPRISES LIMITED and/or its related companies and/or subsidiaries' (hereafter: "Rosslare") exclusive warranty and liability is limited to the warranty and liability statement provided in an appendix at the end of this document.
- This manual describes the maximum configuration of the system with the maximum number of functions, including future options. Therefore, not all functions described in this manual may be available in the specific system and/or product configuration you purchased.
- Incorrect operation or installation, or failure of the user to effectively maintain the system, relieves the manufacturer (and seller) from all or any responsibility for consequent non-compliance, damage, or injury.
- The text, images and graphics contained in the manual are for the purpose of illustration and reference only.
- In no event shall manufacturer be liable for any special, direct, indirect, incidental, consequential, exemplary, or punitive damages (including, without limitation, any and all damages from business interruption, loss of profits or revenue, cost of capital or loss of use of any property or capital or injury).
- All graphics in this manual are for reference only, some deviation between the image(s) and the actual product may occur.
- All wiring diagrams are intended for reference only, the photograph or graphic of the PCB(s) are intended for clearer illustration and understanding of the product and may differ from the actual PCB(s).

1. Introduction

The AC-825IP is an advanced networked access controller and is the backbone of a medium-scale to high-scale security system that can handle up to 100,000 users and 500,000 events.

Each AC-825IP access control unit (ACU) supports up to 6 doors (In/Out), each with 2 inputs and 1 output, and includes four additional auxiliary inputs and two auxiliary outputs.

The number of supported doors, inputs, and outputs can be increased by using the onboard 10-pin expansion slot to connect any of the following expansion boards:

- R-805 – 16 outputs
- S-805 – 16 inputs
- D-805 – 4-door expansion
- P-805 – 16 inputs and 8 outputs

The system currently supports 12 extension boards via RS-485 with Open Supervised Device Protocol (OSDP), of any kind, in addition to the expansion board mounted on top of the AC-825IP panel.

Driven by Rosslare's powerful, flexible and easy to use AxTraxNG™ software, the system provides an ideal, modular and expandable solution for commercial and institutional needs. It provides seamless integration with Rosslare's UL Listed range of RFID proximity, PIN, Proximity & PIN, smart card, and biometric readers with Rosslare's selection of RFID credentials.

The AC-825IP is ready for installation with a mountable and lockable metal enclosure (ME-1515) integrated with a switch, power management board/charger, sounder, and control panel.

Using an onboard Ethernet TCP/IP, multiple local or remote site door subnetworks can connect to the AxTraxNG Client/Server PC software running on Microsoft® Windows® 7/8 operating systems.



The onboard Ethernet TCP/IP was evaluated by UL as a standalone unit and is used for programming use only.

Introduction

The AC-825IP platform consists of the following components:

- AC-825IP networked access controller
- ME-1515 metal enclosure with a detachable illumination bar
- Up to 4 A power management board
- VAC/VDC power switch
- Terminal block removal tool
- 12 x 2.2 k Ω and 12 x 8.2 k Ω resistors for the supervised inputs

1.1 Open Supervised Device Protocol

OSDP allows connecting control panels with various peripheral devices (card readers, control panels, and other security management systems) while unlocking the potential of the onboard computing resources within the system.

Each panel can connect to up to two readers via OSDP.



Any device that is connected to the AC-825IP panel via RS-485 must have a unique serial address.

1.2 AxTraxNG

The AxTraxNG software is custom designed to set up, manage, and supervise all aspects of an access controller's network.

It offers the following capabilities:

1.2.1 Client-Server Structure

AxTraxNG operates through a dedicated AxTraxNG server computer, which communicates with the access control panels and their expansions to serve an unlimited number of network clients.

The server also runs the system's SQL database, which contains settings and definitions for access control across the entire facility. System users can define new users and credentials, and control access permissions. The system includes tools for database backup, input, and export of previous configurations and automatic backup on a periodic basis.

AxTraxNG supports all panel types and offers scalability and flexibility in addition to a range of advanced control features.

Introduction

1.2.2 Configurable Links

The system's configurable links model makes it possible to trigger any chosen output automatically or report a configurable alarm, based on a selected input. This allows easy integration with other access systems such as intruder alarms, CCTV systems, and License Plate Recognition (LPR).



Integration with other access systems was not evaluated by UL.

AxTraxNG can also define a selected set of operations, which are defined in configurable links, when a panel registers a specified user or a group of users. This can be useful, for example, in access control systems. The system can assign users with counters, allowing a limited number of entries to each panel.

1.3 Compatible Readers

The AC-825IP ACU provides support for most of the Wiegand formats, such as 26-bit, 30-bit, 32-bit, 35-bit, and 36-bit, as well as any OSDP readers that may be connected serially to the AC-825IP via RS-485 interface.



Supports UL Listed Rosslare readers. UL Listed OSDP readers should be used with the OSDP port of the AC-825IP.

2. Technical Specifications

2.1 ME-1515 Enclosure

ELECTRICAL SPECIFICATIONS

Enclosure SMPS	Input: 100 to 240 VAC, 1.6 A, 50–60 Hz, switch mode power management board C13 power cord Output: 12 VDC, 4 A
PCBA Input Power	15 VDC, 2 A, regulated power management board
Backup Battery (sold separately)	12 V sealed lead acid (SLA) up to 7 Ah, IEC62133
Relay Outputs	5 A DC, 150 W maximum
Auxiliary Outputs	12 VDC, 1.2 A typical (1.5 A max.)
Fuse	250 V, 2.5 A

OPERATIONAL SPECIFICATIONS

Relays 5 A, Form-C	6
Supervised Inputs	12
Readers (Wiegand Format)	4
Readers (OSDP Format)	2
Expansion Ports	1
Connectivity	TCP/IP, OSDP

OPERATIONAL SPECIFICATIONS (AC-825IP only)

Capacity	Up to 100,000 users
History Event Log Size	Up to 500,000 entries
Time Zones and Groups	256 multi-segment time zones, 64 holidays – each holiday can be multiple days Practically unlimited amount of access groups
Special Features with AxTraxNG	Interlock, first-person delay, auto-relock, scheduled outputs operation, 4 programmable site codes, extended unlocked time, fully interconnectedness, car parking management, antipassback (per reader, between readers)
Security Modes	Normal and Secure

ENVIRONMENTAL SPECIFICATIONS

Operating Temp. Range	-5°C to 50°C (23°F to 122°F)
Storage Temp. Range	-25°C to 50°C (-13°F to 122°F)
Operating Humidity Range	0 to 85% (non-condensing)

Technical Specifications

MECHANICAL SPECIFICATIONS

Enclosure Dimensions (H x W x D)	346 x 404 x 101 mm (13.6 x 15.9 x 4.0 in.)
Enclosure Weight*	4.6 kg (10.1 lb)
PCBA Dimensions (H x W)	224 x 164 mm (8.8 x 6.46 in.)
PCBA Weight	400 g (14.1 oz)
Backup Battery Dimensions (H x W x D)	95 x 150 x 65 mm (3.7 x 5.9 x 2.6 in.)
Fuse Dimensions (H x W)	20 x 5 mm (0.8 x 0.2 in.)

* For weight purposes, the ME-1515 enclosure includes the metal box, AC input, DC output and LED bar.

2.2 Expansions for AC-825IP

Specification	R-805	S-805	D-805	P-805
---------------	-------	-------	-------	-------

OPERATIONAL SPECIFICATIONS

Relays 5 A, Form-C	16	N/A	4	8
Supervised Inputs	N/A	16	8	16
Readers (Wiegand format)	N/A	N/A	4	N/A
Readers (OSDP format)	N/A	N/A	N/A	N/A
Connectivity	OSDP			

ENVIRONMENTAL SPECIFICATIONS

Operating Temp. Range	-5°C to 50°C (23°F to 122°F)			
Storage Temp. Range	-25°C to 50°C (-13°F to 122°F)			
Operating Humidity Range	0 to 85% (non-condensing)			

MECHANICAL SPECIFICATIONS

Weight	230 g (8.1 oz)	150 g (5.3 oz)	200 g (7.1 oz)
Dimensions (H x W x D)	178 x 87 x 30 mm (7.0 x 3.4 x 1.2 in.)		

3. AC-825IP Panel Setup

 The unit should only be installed by a professional service person.

Each AC-825IP panel controls 6 or 10 doors (with the D-805) (3 or 5 doors in double reader per door mode). The panels connect together in a network and are controlled by a central server computer, running the AxTraxNG software system.

Figure 1 shows an example setup for a network of AC-825IP access control panels.

Figure 1: Sample AC-825IP Configuration

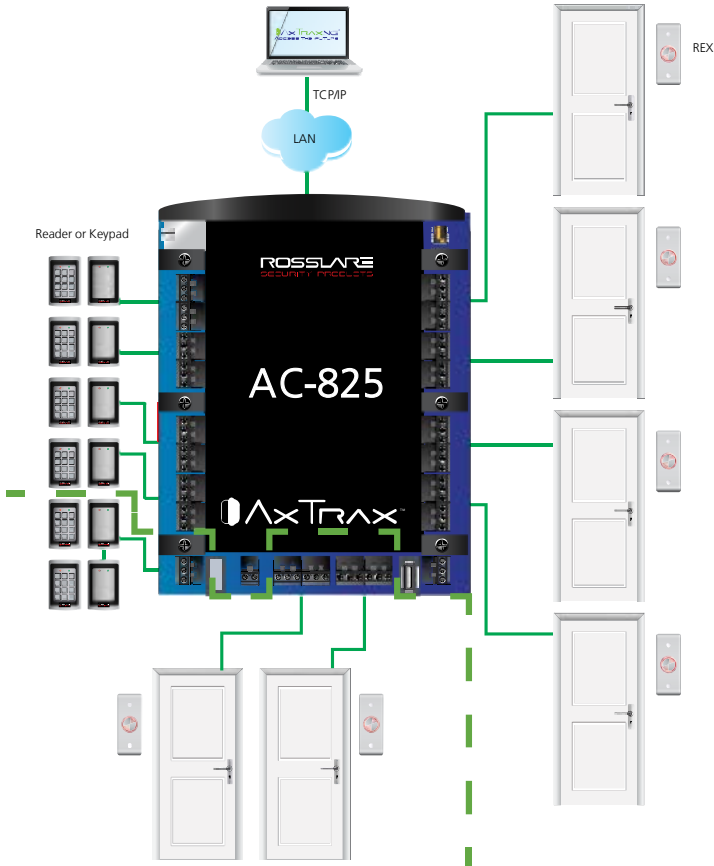

AC-825IP Panel Setup



The highlighted area indicates the use of OSDP readers and their I/O connectivity. Bushings are needed for any conductors leaving the enclosure through the provided openings.

3.1 Mounting

The AC-825IP control panel either comes pre-mounted within the ME-1515 enclosure, which then needs to be wall mounted, or you can mount the control panel directly onto a wall using the DIN rail enclosure.

3.1.1 Mounting the ME-1515 Enclosure

When selecting an area for mounting, ensure the location is flat.

To mount the ME-1515:

1. Using the locations shown in Figure 2, drill holes in the wall.

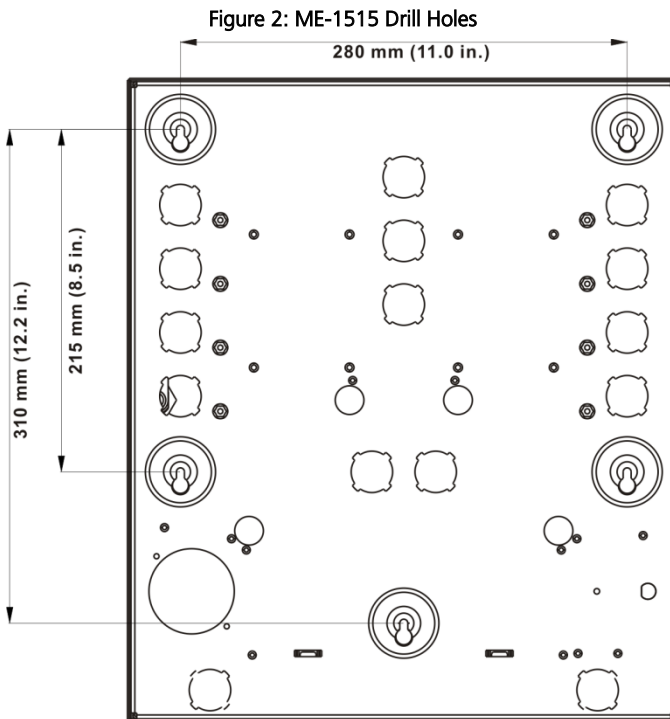

2. Insert masonry anchors into the drilled holes.
3. Mount the enclosure onto the wall.

AC-825IP Panel Setup

4. Plug in a C13 power cord (female) into the C14 (male) slot located on the bottom left of the ME-1515 casing (Figure 3).

Figure 3: C14 Socket

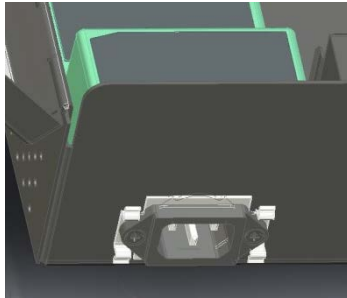

Optionally, you can add Pull-Safe™ cable locks to secure the C13 power cord (see Section 3.1.2).

The maximum power rating and input allowed is indicated on the cover of the AC terminal inside the enclosure (Figure 4).

Figure 4: Location of the Maximum Power Rating Sticker



3.1.2 Connecting the Pull-Safe™ Cable Locks

If you want to add the Pull-Safe™ cable locks, you must do so prior to mounting the enclosure onto the wall.

To install the Pull-Safe cable locks:

1. With the C13 power cord plugged in to the C14 slot on the back cover of the ME-1515 enclosure, place the cable holders on either side of the power cord (Figure 5).

Figure 5: Attaching the Pull-Safe Cable Locks

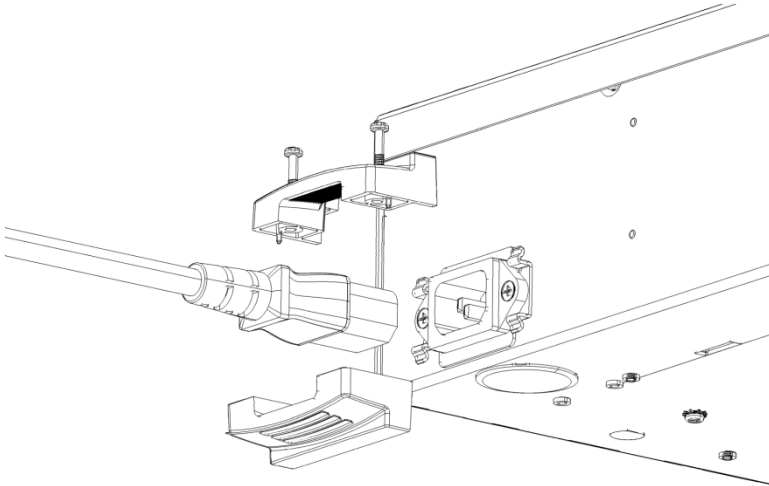

2. Insert the screws into their designated areas and screw them in tightly.
3. Pull on the cord to check that the cord is secured.

AC-825IP Panel Setup

3.1.3 Mounting using the DIN Rail

The AC-825IP control panel and its extensions can also be installed directly on a wall (without the ME-1515 enclosure) using a DIN rail and the accompanying casing for the AC-825IP panel or extension(s).

To mount using a DIN rail:

1. Attach the DIN rail to a wall in the designated area.

Figure 6: DIN Rail



2. Once the AC-825IP panel or extension is positioned inside the casing, pull the 'UNLOCK' handle on the left side of the casing to the left (Figure 7).

Figure 7: Unlocking the DIN Rail Handle

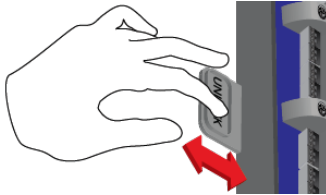

AC-825IP Panel Setup

3. Position the panels and/or extensions on the DIN rail with its title facing you.

Figure 8: Positioning the Panels

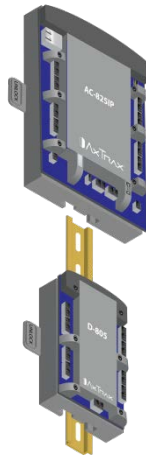

4. Release the handle. The unit is secured horizontally on the DIN rail.
5. Add a kind of stopper or screw underneath each unit so the unit does not slide down the DIN rail.

Figure 9: Adding a Screw as a Stopper

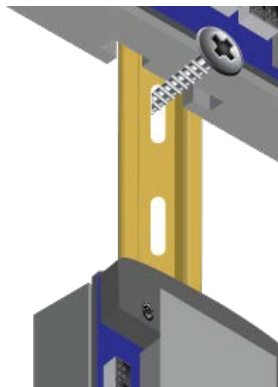

If you have multiple units along a DIN rail, we suggest having a 2-cm gap between each unit.

AC-825IP Panel Setup

We suggest installing the DIN rail inside an electrical cupboard. We recommend using the EN 50022 standard with the following dimensions as shown in Figure 10.

Figure 10: DIN Rail Dimensions (Top View)

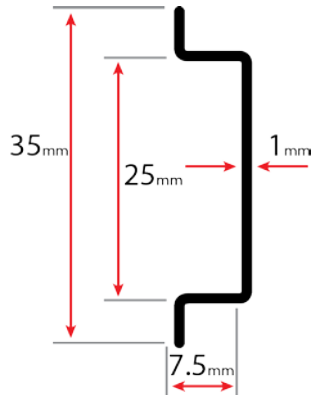

Each unit needs to be connected to a power supply. For further information, please refer to the electrical specifications (Chapter 2).

3.2 Input Wiring – Supervised Inputs

When wiring the AC-825IP for supervised inputs, resistors should be placed on the input switch and not on the terminal block.

Figure 11 presents a view of the inputs and their connection options.

Figure 11: Input Wiring – Supervised Inputs

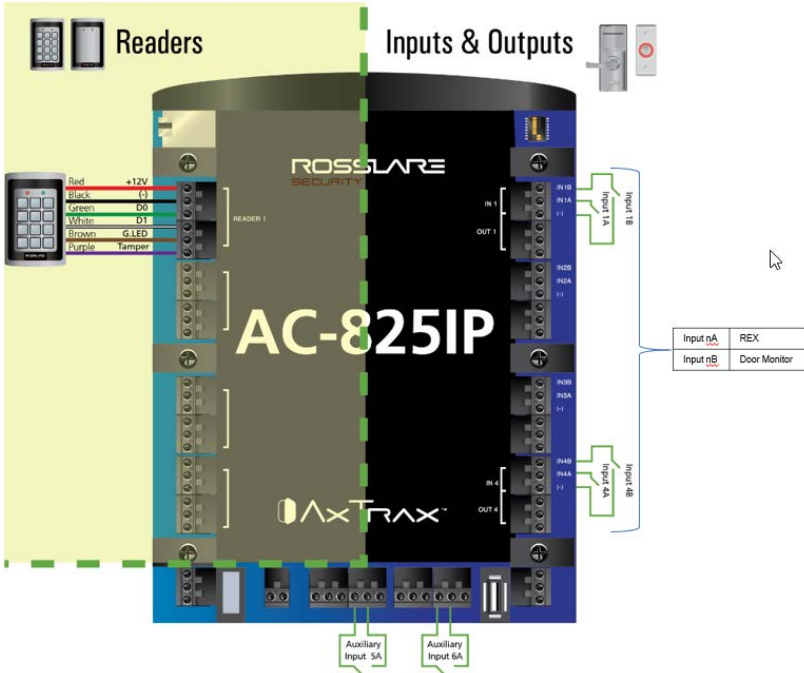

For more details on reader connectivity, refer to Figure 21 and Figure 22 in Section 3.7.

3.3 Output Wiring

Figure 12 and Figure 13 illustrate wiring for two main types of 12 VDC electrical release mechanisms. Other electrical devices can be switched using the voltage free relay contacts.

Figure 12: Door Lock – Failed Close

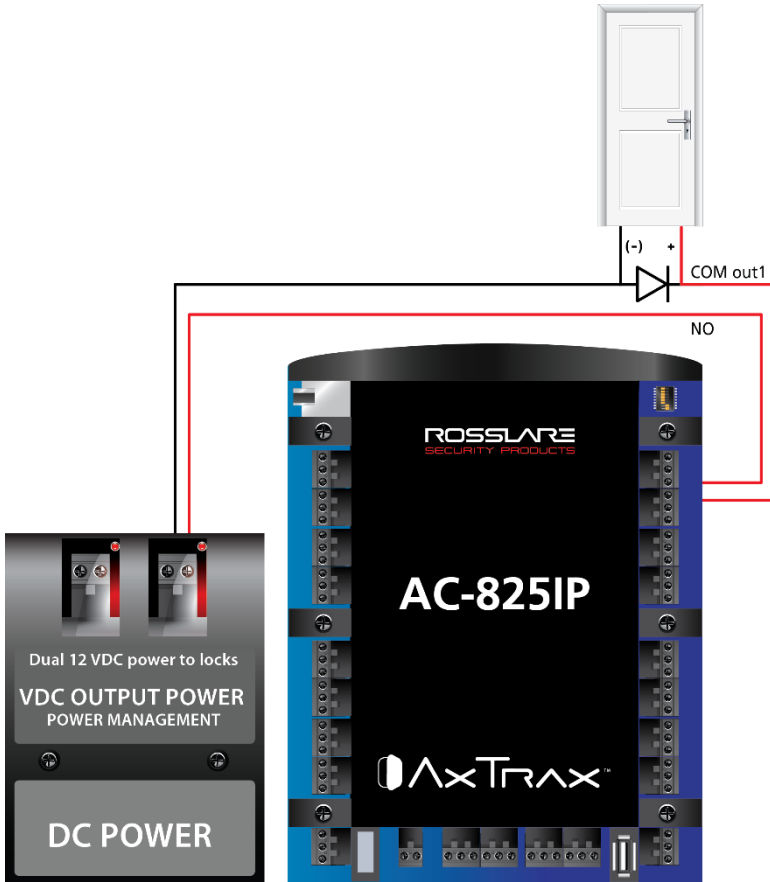

Figure 13: Door Lock – Failed Open



3.4 Power Management

Figure 14 illustrates the AC-825IP ACU within the ME-1515 enclosure. It is recommended to add a 12 VDC lead acid backup battery in case the power management board fails (see Chapter 2). If the main input is 12 VDC, wire it to the power management board, which has a load rating of up to 4 A for lock connectivity (for battery installation instructions, please refer to Section 3.1). If 4 A is not sufficient, an external power supply should be added according to the electrical requirements. For more information, refer to Section 4.3.

Figure 14: AC-825IP in the ME-1515 Enclosure

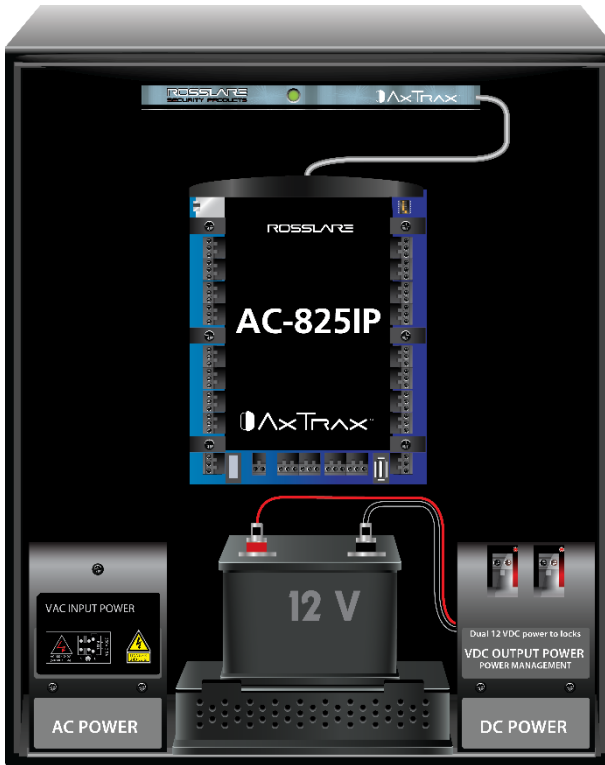

3.5 AC-825IP Wiring Ports

Figure 15 presents a detailed view of the access control panel with all its wiring communications.

Figure 15: AC-825IP Wiring Communications

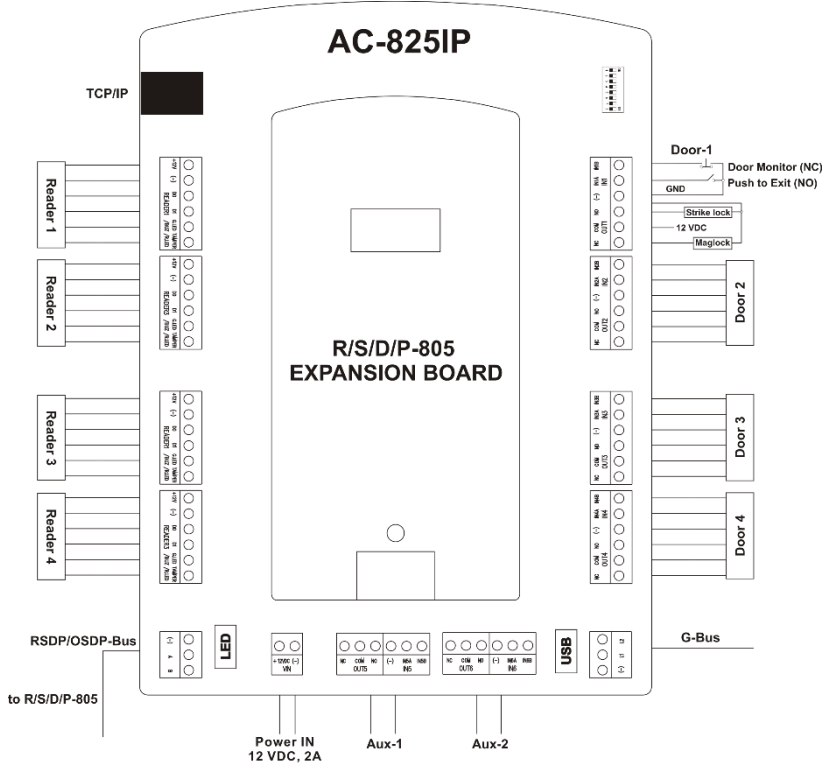

AUX1 and AUX 2 are additional auxiliary inputs and auxiliary outputs. Refer to Chapter 2 for maximum power ratings and further information.

 The USB G-bus ports and DIP switches are currently not functional.

AC-825IP Panel Setup

3.6 R/S/D/P-805 Extension Board Setup

There are four types of expansion boards as follows:

- R-805 – The R-805 is an optional expansion board that adds 16 outputs to the access control panel.
- S-805 – The S-805 is an optional expansion board that adds 16 supervised inputs to the access control panel.
- D-805 – The D-805 is an optional door expansion board that adds 4 reader inputs, 4 outputs (Form C, 5 A), and 8 supervised inputs to the access control panel.
- P-805 – The P-805 is an optional expansion board that adds 16 supervised inputs and 8 outputs to the access control panel.

Each extension board can be either located inside an ME-1515 enclosure or can be installed directly on a wall using the included DIN rail attachment. Each ME-1515 can contain up to two extension boards of different types.

One extension board can also be connected to the AC-825IP control panel using the expansion slot (Figure 16).

Figure 16: Slot for Expansion Board Attachment



When adding an expansion board to the expansion slot of the AC-825IP panel, make sure the power to the control panel is off.

The system can support up to 12 expansion boards via OSDP.

Each ME-1515 is self-powered.

When multiple expansions are needed, we recommend using a daisy chain connection.

AC-825IP Panel Setup

3.6.1 Daisy Chain System

Figure 17 shows an example daisy chain setup for a network of one AC-825IP access control panel plus 6 expansion boards using four ME-1515 enclosures.

Figure 17: Daisy Chain Setup



The first expansion board is connected to the AC-825IP panel using the OSDP/RSDP bus (serial bus) at the bottom left of the panel (Figure 18).

Figure 18: OSDP/RSDP Bus on AC-825IP Panel

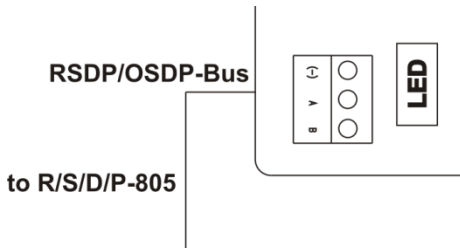

Any subsequent expansions are connected to each other using the RSDP bus located the bottom center of the expansion (Figure 19).

Figure 19: RSDP Bus on Expansion Board

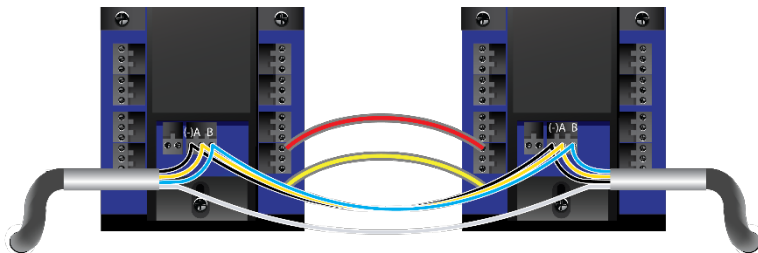

Each serial connector (A, B, and -) must be connected with its equivalent.



To connect an expansion to a panel or another expansion, you have to slide the plastic covering at the bottom of the expansion board to expose the connectors.

AC-825IP Panel Setup

The RS-485 bus must be terminated at both ends of the cable with a 100-120 Ω resistor (Figure 20).

Figure 20: Termination with Resistor

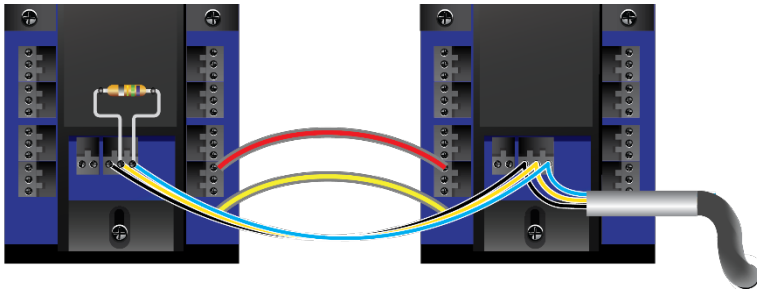

If multi-pair twisted pair cable is used, one pair shall be used for A+ and B- signals (blue and white/blue) and one pair for GND (orange + white/orange). Unused wires should be terminated with 100 Ω resistors to ground at both ends of the cable.



The maximum distance between any two ME-1515 units is 1 km. Similarly, the maximum distance between the first ME-1515 and the last ME-1515 is 1 km.



The recommended cable type to be used is STP cat5 (shielded twisted pair category 5). We recommend using a 20-24-AWG cable.

3.6.2 DIP Switching





A piggybacked expansion does not have a DIP switch address.













Each expansion board has 4 switches to determine its ID in the system. Each switch can be set either up or down thus creating up to 16 combinations. However, an AC-825IP panel supports up to 11 unique serial addresses (readers) per panel, so only a maximum of 11 of the 16 serial addresses can be used at any given time.

Table 1 shows the serial address of each of these 16 combinations.

Table 1: Serial Address and DIP Switch Combinations

Serial Address	DIP Switch Setting
2	
3	
4	

AC-825IP Panel Setup

Serial Address	DIP Switch Setting
5	
6	
7	
8	
9	
10	
11	
12	
13	
	
	
	
	

Rosslare readers that support OSDP operation are compatible with most OSDP commands. The reader address is set using DIP switches on the back of the reader.

AC-825IP Panel Setup

The DIP switch settings are as follows:

DIP Switches 1 to 4

These switches set the address of the reader for OSDP protocol.

DIP Switch 1 is MSB and DIP switch 4 is LSB. The address is the DIP switch state +1.

Examples:

- All the DIP switches in Off position, state is = 0 => address = 2 (in AxTraxNG)
- DIP switches 1, 3, 4 in On position and 2 in Off position, state is = 0x0B => address = 0x0C = 13



In every system, each board's ID must be unique.



The ID is set only in the initialization phase. The system does not synchronize if an existing board's ID is changed or if a board is added or removed. The system must be initialized to synchronize the IDs.

3.7 Readers and Cable Length

Readers are supplied with cables having a limited length. The color of the cable cover represents the cable's functionality according to the Wiegand and OSDP standards (Figure 21 and Figure 22).

Figure 21: Reader Wiring – Wiegand

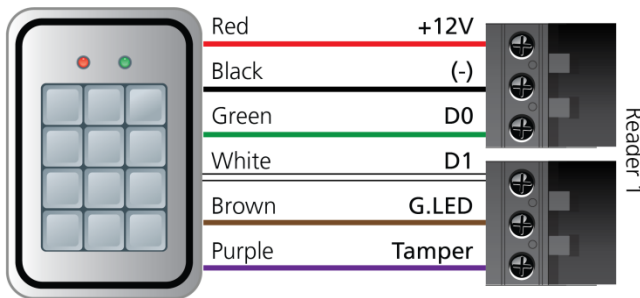
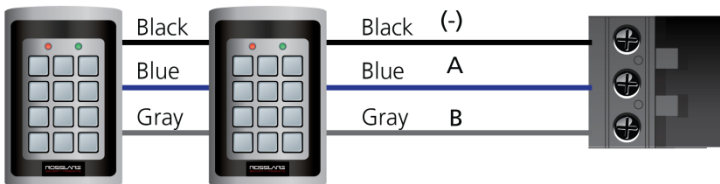

Figure 22: Reader Wiring – OSDP



AC-825IP Panel Setup

If you wish to extend the cable distance, make sure you use the correct cable according to the cable color.

Power to the OSDP readers is to be taken from the reader +12 V outputs.



Do not connect more than two readers per each +12 V output.



Some readers are not supplied with a cable. Please refer to the reader's manual for connecting it to the relevant reader port.



OSDP readers **MUST** be set to addresses 13 and 14.

Refer to the reader specifications for the maximum cable length, typically 150 m (492 ft) with an 18 AWG cable.

4. Input and Output Connections

This chapter describes the AC-825IP access control panel's input and output connections.

4.1 Input Types

There are four input types:

- Normally Closed (N.C.)
- Normally Open (N.O.)
- Single EOL resistor
- Double EOL resistor

Supervised inputs have three states:

- Normal
- Abnormal
- Trouble

The Trouble state is caused by either tampering with the input circuit or by a faulty hardware installation. Once an input is configured as a supervised input, add a resistor of 2.2 k Ω , 8.2 k Ω , or both on the input circuit. See the following diagrams.

4.1.1 Normally Open Input Connection

A Normally Open Input has 2 states:

- Switch Open – Normal State:
Loop resistance = Infinite (open circuit)
- Switch Closed – Abnormal State:
Loop resistance = 0 (short circuit)

Figure 23: Normally Open Input Connection



4.1.2 Normally Closed Input Connection

A Normally Closed Input has two states:

- Switch Closed – Normal State:
Loop resistance = 0 (short circuit)
- Switch Open – Abnormal State:

Input and Output Connections

Loop resistance = Infinite (open circuit)

Figure 24: Normally Closed Input Connection

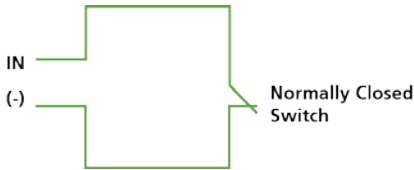

4.1.3 Normally Open Supervised Single EOL Resistor Input Connection

Connect an 8.2 k Ω resistor in parallel to the input switch contacts.

A Normally Open Supervised Input has 3 states:

- Switch Open – Normal State:
Loop resistance = 8.2 k Ω
- Switch Closed – Abnormal State:
Loop resistance = 0 (short circuit)
- Open circuit across input terminals – Trouble State:
Loop resistance = Infinite (open circuit).

Figure 25: Normally Open Supervised Input (Single Resistor)

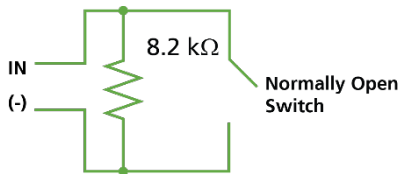

4.1.4 Normally Open Supervised Double EOL Resistor Input Connection

Connect a 2.2 k Ω resistor in series to the input switch contacts.

Connect an 8.2 k Ω resistor parallel to the input switch contacts.

A Normally Open Supervised Input has 3 states:

- Switch Open – Normal State:
Loop resistance = 10.4 k Ω
- Switch Closed – Abnormal State:
Loop resistance = 2.2 k Ω
- Open circuit (infinite loop resistance) or short circuit (0 resistance) across input terminals – Trouble State

Input and Output Connections

Figure 26: Normally Open Supervised Input (Double Resistor)

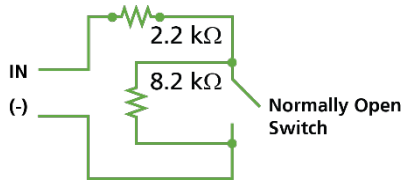

4.1.5 Normally Closed Supervised Single EOL Resistor Input Connection

Connect a 2.2 kΩ resistor in series to the input switch contacts.

A Normally Closed Supervised Input has 3 states:

- Switch Closed – Normal State:
Loop resistance = 2.2 kΩ
- Switch Open – Abnormal State:
Loop resistance = Infinite (open circuit)
- Short circuit across input terminals – Trouble State:
Loop resistance = 0 (short circuit)

Figure 27: Normally Closed Supervised Input (Single Resistor)

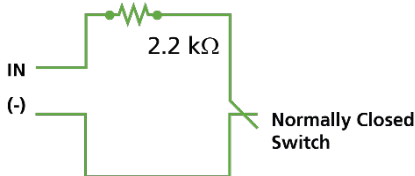

4.1.6 Normally Closed Supervised Double EOL Resistor Input Connection

Connect a 2.2 kΩ resistor in series to the input switch contacts.

Connect an 8.2 kΩ resistor parallel to the input switch contacts.

A Normally Closed Supervised Input has 3 states:

- Switch Closed – Normal State:
Loop resistance = 2.2K
- Switch Open – Abnormal State:
Loop resistance = 10.4 kΩ
- Open circuit (infinite loop resistance) or short circuit (0 resistance) across input terminals – Trouble State

Figure 28: Normally Closed Supervised Input (Double Resistor)

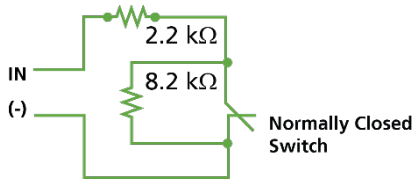

4.2 Inputs Description

4.2.1 Request-to-Exit Button (REX) Input

Use the REX Input to open a door directly. Typically, the REX input is connected to a Normally Open push button that is located inside the premises. The push button is generally located in an easy-to-access position and opens a door without reading any credential.

Scenario	Setting
Two Readers per Door	Door 1 – IN 1A
	Door 2 – IN 3A
	Door 3 – IN 5A
One Reader per Door	Door 1 – IN 1A
	Door 2 – IN 2A
	Door 3 – IN 3A
	Door 4 – IN 4A
	Door 5 – IN 5A
	Door 6 – IN 6A

REX Inputs functions when using D-805:

Scenario	Setting
Two Readers per Door	Door 4 – IN 1C
	Door 5 – IN 3C
One Reader per Door	Door 7 – IN 1C
	Door 8 – IN 2C
	Door 9 – IN 3C
	Door 10 – IN 4C

4.2.2 Door Monitor Input

The Door Monitor Input typically connects to a Normally Closed door sensing micro-switch for door status monitoring. Using Door Monitor enables many advanced options such as door forced alarm, door held open warnings, interlocking doors and more.

Input and Output Connections

Scenario	Setting
Two Readers per Door	Door 1 – IN 1B
	Door 2 – IN 3B
	Door 3 – IN 5B
One Reader per Door	Door 1 – IN 1B
	Door 2 – IN 2B
	Door 3 – IN 3B
	Door 4 – IN 4B
	Door 5 – IN 5B
	Door 6 – IN 6B
Two Readers per Door	Door 4 – IN 1D
	Door 5 – IN 3D
One Reader per Door	Door 7 – IN 1D
	Door 8 – IN 2D
	Door 9 – IN 3D
	Door 10 – IN 4D

4.2.3 General Purpose Inputs

These are free inputs that can be used for various functions. The following should be defined:

Scenario	Setting
Two Readers per Door	IN 2A
	IN 2B
	IN 4A
	IN 4B
	IN 6A
	IN 6B
One Reader per Door	(no general purpose inputs available)

General purpose inputs are suitable for most uses. For example, they might be used to detect tampering, to activate trouble signals, or to monitor a power management board failure.

General purpose inputs functions when using S-805 or D-805:

Unit	Expansions
S-805	IN 1S to IN 16S
P-805	IN 1P to IN 16P
D-805	IN 2C
	IN 2D
	IN 4C

Input and Output Connections

IN 4D

4.3 Outputs

Rosslare Security recommends the use of suppression diodes for all outputs that activate an inductive load.

4.3.1 Door Lock

There are two types of door locking devices:

- Fail open (fail secure)
- Fail close (fail safe)

The following should be defined:

Scenario	Setting
Two readers per door	Door 1 – OUT 1
	Door 2 – OUT 3
	Door 3 – OUT 5
One reader per door	Door 1 – OUT 1
	Door 2 – OUT 2
	Door 3 – OUT 3
	Door 4 – OUT 4
	Door 5 – OUT 4
	Door 6 – OUT 6

Door outputs when using D-805:

Scenario	Setting
Two Readers per Door	Door 1 – OUT 1
	Door 2 – OUT 3
	Door 3 – OUT 5
	Door 4 – OUT 1D
	Door 5 – OUT 3D
One Reader per Door	Door 1 – OUT 1
	Door 2 – OUT 2
	Door 3 – OUT 3
	Door 4 – OUT 4
	Door 5 – OUT 5
	Door 6 – OUT 6
	Door 7 – OUT 1D
	Door 8 – OUT 2D
	Door 9 – OUT 3D
	Door 10 – OUT 4D

Input and Output Connections

The output can sink current from any power management board (see Section 3.4).



For UL installations, the installer must configure the system as fail-safe to comply with NFPA (National Fire Protection Association) regulations.

4.4 Card Readers and Keypads

Each access control panel can be connected to a maximum of 6 readers (or 10 readers when using D-805).

A keypad is required for any reader mode that requires PIN code entries, such as "Card or PIN", "PIN Only" or "Card and PIN (Secured mode)".

When connecting a reader, the following should be defined:

Scenario	Setting
Two Readers per Door	Door 1 – Reader 1 IN/OUT
	Door 1 – Reader 2 IN/OUT
	Door 2 – Reader 3 IN/OUT
	Door 2 – Reader 4 IN/OUT
	Door 3 – Reader 5 (OSDP) IN/OUT
	Door 3 – Reader 6 (OSDP) IN/OUT
One Readers per Door	Door 1 – Reader 1 IN/OUT
	Door 2 – Reader 2 IN/OUT
	Door 3 – Reader 3 IN/OUT
	Door 4 – Reader 4 IN/OUT
	Door 5 – Reader 5 (OSDP) IN/OUT
	Door 6 – Reader 6 (OSDP) IN/OUT

Input and Output Connections

When using the D-805, the following should be defined:

Scenario	Setting
Two readers per door:	Door 1 – Reader 1 IN/OUT
	Door 1 – Reader 2 IN/OUT
	Door 2 – Reader 3 IN/OUT
	Door 2 – Reader 4 IN/OUT
	Door 3 – Reader 5 (OSDP) IN/OUT
	Door 3 – Reader 6 (OSDP) IN/OUT
	Door 4 – Reader 1D IN/OUT
	Door 4 – Reader 2D IN/OUT
	Door 5 - Reader 3D IN/OUT
	Door 5 - Reader 4D IN/OUT
One readers per door:	Door 1 – Reader 1 IN/OUT
	Door 2 – Reader 2 IN/OUT
	Door 3 – Reader 3 IN/OUT
	Door 4 – Reader 4 IN/OUT
	Door 5 – Reader 5 (OSDP) IN/OUT
	Door 6 – Reader 6 (OSDP) IN/OUT
	Door 7 – Reader 1D IN/OUT
	Door 8 – Reader 2D IN/OUT
	Door 9 – Reader 3D IN/OUT
	Door 10 – Reader 4D IN/OUT

Use the AxTraxNG software to set the readers for IN or OUT use and to set the data transmission format for each reader.

The reader's tamper output connects to the access control panel's Reader-Tamper input. If the reader is interfered with, a trouble signal can be generated.

The controller activates the LED control for the time the door is open.

5. AC-825IP Hardware Settings

Access control panels, configured as either single reader door or double reader door controllers, have two readers, IN or OUT.

Expansion boards attached to the expansion slot of the panel must be configured the same as the panel (single or double door).

Expansion boards connected via RS-485 standard can be configured independently of the panel.



When configuring two readers per door, the two readers connected to a door must be using the same format (OSDP or Wiegand).

Table 2: Possible Hardware Settings

Connectors	Description	Setup
Two Readers per Door:		
Outputs	Door 1 Lock output	(OUT 1)
	Door 2 Lock output	(OUT 3)
	Door 3 Lock output	(OUT 5)
	General purpose output	(OUT 2)
	General purpose output	(OUT 4)
	General purpose output	(OUT6)
Inputs	Door 1: Request-to-Exit	(IN 1A)
	Door monitor input	(IN 1B)
	Door 2: Request-to-Exit	(IN 3A)
	Door monitor input	(IN 3B)
	Door 3: Request-to-Exit	(IN5A)
	Door monitor input	(IN5B)
Readers	Reader1 – Door1	Door Entry or Exit
	Reader2 – Door1	Door Exit or Entry
	Reader3 – Door2	Door Entry or Exit
	Reader4 – Door2	Door Exit or Entry
	Reader5 (OSDP) – Door3	Door Exit or Entry
	Reader6 (OSDP) – Door3	Door Exit or Entry
One Reader per Door:		
Outputs	Door1 Lock output	(OUT 1)
	Door2 Lock output	(OUT 2)
	Door3 Lock output	(OUT 3)
	Door4 Lock output	(OUT 4)
	Door5 Lock output	(OUT 5)

AC-825IP Hardware Settings

Connectors	Description	Setup
Inputs	Door6 Lock output	(OUT 6)
	Door1 Request-to-Exit	(IN 1A)
	Door monitor input	(IN 1B)
	Door2 Request-to-Exit	(IN 2A)
	Door monitor input	(IN 2B)
	Door3 Request-to-Exit	(IN 3A)
	Door monitor input	(IN 3B)
	Door4 Request-to-Exit	(IN 4A)
	Door monitor input	(IN 4B)
	Door5 Request-to-Exit	(IN 5A)
	Door monitor input	(IN 5B)
	Door6 Request-to-Exit	(IN 6A)
Door monitor input	(IN 6B)	
Readers	Reader1	(Door1 IN/OUT)
	Reader2	(Door2 IN/OUT)
	Reader3	(Door3 IN/OUT)
	Reader4	(Door4 IN/OUT)
	Reader5	(Door5 IN/OUT)
	Reader6	(Door6 IN/OUT)
Two Readers per Door with 10 Readers (D-805):		
Outputs	Door1 Lock output	(OUT 1)
	Door2 Lock output	(OUT 3)
	Door3 Lock output	(OUT 5)
	Door4 Lock output	(OUT 1D)
	Door5 Lock output	(OUT 3D)
Inputs	Door1 Request-to-Exit	(IN 1A)
	Door1 monitor input	(IN 1B)
	Door2 Request-to-Exit	(IN 3A)
	Door2 monitor input	(IN 3B)
	Door3 Request-to-Exit	(IN 5A)
	Door3 monitor input	(IN 5B)
	Door4 Request-to-Exit	(IN 1C)
	Door4 monitor input	(IN 1D)
	Door5 Request-to-Exit	(IN3C)
	Door5 monitor input	(IN3D)
Readers	Reader1	(Door1 IN/OUT)
	Reader2	(Door1 OUT/IN)
	Reader3	(Door2 IN/OUT)

AC-825IP Hardware Settings

Connectors	Description	Setup
	Reader4	(Door2 OUT/IN)
	Reader5 (OSDP)	(Door3 IN/OUT)
	Reader6 (OSDP)	(Door3 OUT/IN)
	Reader1D	(Door4 IN/OUT)
	Reader2D	(Door4 OUT/IN)
	Reader3D	(Door5 OUT/IN)
	Reader4D	(Door5 OUT/IN)
One Reader per Door with 10 Readers (D-805)		
Outputs	Door1 Lock output	(OUT 1)
	Door2 Lock output	(OUT 2)
	Door3 Lock output	(OUT 3)
	Door4 Lock output	(OUT 4)
	Door5 Lock output	(OUT 5)
	Door6 Lock output	(OUT 6)
	Door7 Lock output	(OUT 1D)
	Door8 Lock output	(OUT 2D)
	Door9 Lock output	(OUT 3D)
	Door10 Lock output	(OUT 4D)
Inputs	Door1 Request-to-Exit	(IN 1A)
	Door2 Request-to-Exit	(IN 2A)
	Door3 Request-to-Exit	(IN 3A)
	Door4 Request-to-Exit	(IN 4A)
	Door5 Request-to-Exit	(IN 5A)
	Door6 Request-to-Exit	(IN 6A)
	Door7 Request-to-Exit	(IN 1C)
	Door8 Request-to-Exit	(IN 2C)
	Door9 Request-to-Exit	(IN 3C)
	Door10 Request-to-Exit	(IN 4C)
Readers	Reader1	(Door1 IN/OUT)
	Reader2	(Door2 OUT /IN)
	Reader3	(Door3 IN/OUT)
	Reader4	(Door4 OUT /IN)
	Reader5 (OSDP)	(Door5 IN/OUT)
	Reader6 (OSDP)	(Door6 OUT /IN)
	Reader1D	(Door7 IN/OUT)
	Reader2D	(Door8 OUT /IN)
	Reader3D	(Door9 OUT /IN)
	Reader4D	(Door10 OUT /IN)

5.1 DIP Switch Configuration

Currently not used.

5.2 Setting AC-825IP Panel Type in AxTraxNG

The AC-825IP panel type is defined using AxTraxNG. There are two panel types: a panel with one reader per each door or a panel with two readers per each door. Please refer to the AxTraxNG manual for further details.

6. Communications

Communication lines are used to upload and download information between the AC-825IP panel and the AxTraxNG server using an IP network.

6.1 TCP/IP Network Connection

The computer running the AxTraxNG server can communicate with the access control panels via an IP network. The connection settings are controlled within the AxTraxNG Client software.

AC-825IP panels connect to the IP network using an onboard network module.

6.1.1 LAN and WAN Requirements

The devices can be connected to an IP network using any valid network address.

Figure 29 illustrates the connection of a single AC-825IP to a computer via a LAN network.

Figure 29: Connecting Multiple AC-825IP Panels to the AxTraxNG Server

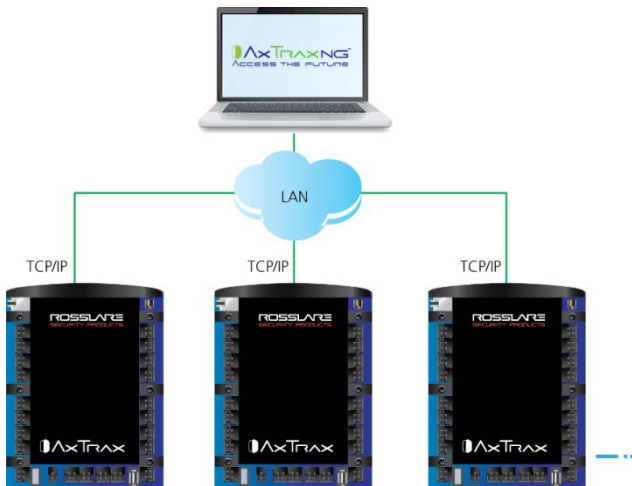

Communications

The maximum distance from the Ethernet port of the panel to the LAN connection is 99.97 m (328 ft).

When the IP connection is implemented over a WAN, it is then possible to communicate with the panel via the Internet with an AxTraxNG client, allowing multiple access controllers worldwide to be reached.

Before connecting a panel by an IP connection for the first time, the AxTraxNG software must configure the device. Settings are then stored in the device (see the *AxTraxNG Software Manual for further details*).

A. Limited Warranty

The full ROSSLARE Limited Warranty Statement is available in the Quick Links section on the ROSSLARE website at www.rosslaresecurity.com.

Rosslare considers any use of this product as agreement to the Warranty Terms even if you do not review them.



AC-825IP

Asia Pacific, Middle East, Africa

Rosslare Enterprises Ltd.
Kowloon Bay, Hong Kong
Tel: +852-2795-5630
Fax: +852-2795-1508
support.apac@rosslaresecurity.com

United States and Canada

Rosslare Security Products, Inc.
Southlake, TX, USA
Toll Free: +1-866-632-1101
Local: +1-817-305-0006
Fax: +1-817-305-0069
support.na@rosslaresecurity.com

Europe

Rosslare Israel Ltd.
Rosh HaAyin, Israel
Tel: +972-3-938-6838
Fax: +972-3-938-6830
support.eu@rosslaresecurity.com

Latin America

Rosslare Latin America
Buenos Aires, Argentina
Tel: +54-11-4001-3104
support.la@rosslaresecurity.com

China

Rosslare Electronics (Shenzhen) Ltd.
Shenzhen, China
Tel: +86-755-8610-6842
Fax: +86-755-8610-6101
support.cn@rosslaresecurity.com

India

Rosslare Electronics India Pvt Ltd.
Tel/Fax: +91-20-40147830
Mobile: +91-9975768824
sales.in@rosslaresecurity.com

ROSSLARE
SECURITY PRODUCTS

