

AY-B85x0

Indoor Optical Fingerprint 1:N with RFID Reader

User Guide



1. Introduction

The AY-B85x0 series are biometric fingerprint and RFID card readers with a compact design, which are suitable for installing on a door frame. It includes a biometric fingerprint sensor and RFID card reader for higher security requirements.

Using AxTraxNG, you can register and delete users (see the *AxTraxNG™ Software Installation and User Manual*). Alternatively, you can use master cards to register and delete users while in an offline state.

The standard Wiegand output seamlessly connects to the third-party access controllers.

The reader comes in two models:

- AY-B8520 – 125 kHz EM RFID card reader
- AY-B8550 – 13.56 MHz MIFARE card reader

2. Installation

2.1. Mounting

1. Using the back panel as a guide, drill four holes for mounting the back plate onto the surface.

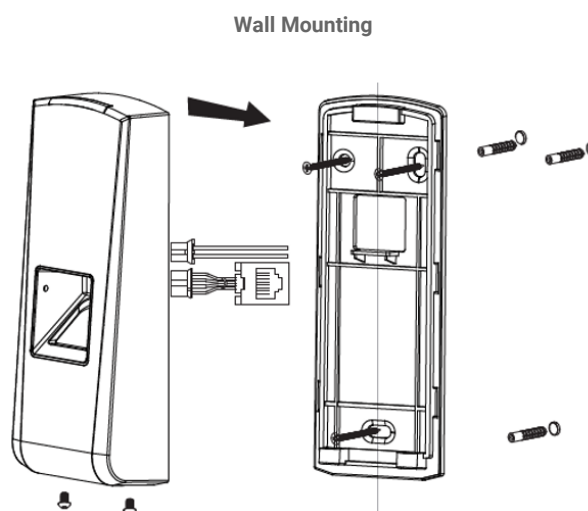

2. Insert a suitable wall plug into each screw hole.
3. Drill a 10-mm (7/16") hole for the cable.

4. Screw the back plate onto the wall.
5. Connect the reader to the controller (see [Wiring Instructions](#)). A linear type power supply is recommended.
6. Attach the reader to the back plate and secure the reader to the back plate with the provided security screw and tools.

2.2. Wiring Instructions

To connect the unit as a reader to an access control unit:

1. Select the appropriate connections according to the following table and figure:

Function	PIN	Cable Color	Description
P1			
Power	1	Red	12 VDC
	2	Black	GND
P2			
Wiegand Output	1	Green	Wiegand DATA0 Output
	2	White	Wiegand DATA1 Output
	3	Black	GND
Pulse Signal	4	Yellow	RS-485A
	5	Purple	RS-485B
	6	Black	GND

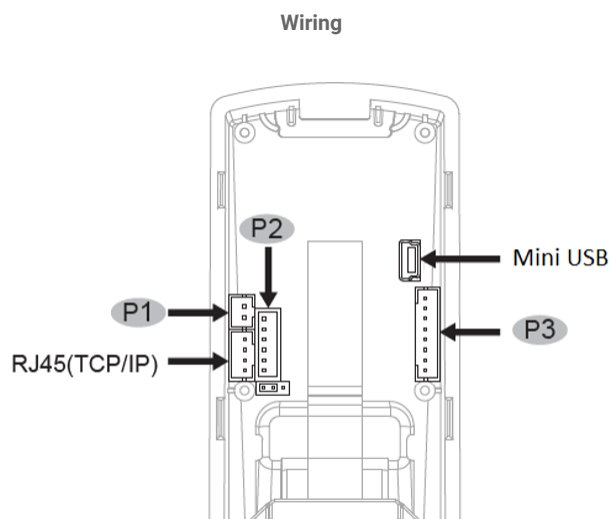

2. Prepare the controller cable by cutting its jacket back about 3 cm (1¼") and strip the insulation from the wires about 1.3 cm (½").
3. Splice the reader's pigtail wires to the corresponding controller wires and cover each joint with insulating tape.
4. Trim and insulate the ends of all unused conductors individually. Do not short any unused wires together.



- The individual wires from the reader are color coded according the Wiegand standard.
- When using a separate power supply for the reader, this supply and that of the controller must have a common ground.
- The reader’s cable shield wire should be preferably attached to an earth ground, or a signal ground connection at the panel, or power supply end of the cable. This configuration is best for shielding the reader cable from external interference.

3. Operation

3.1. Registering a Management Card

Register a management card (Enroll and Delete).

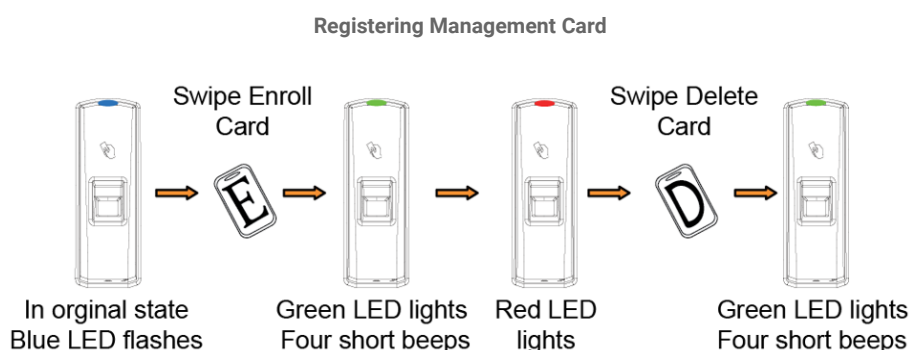

3.2. Resetting a Management Card (Enroll and Delete)

To reset a management card, press and hold the function button located inside the back cover of the reader until you hear beeps.

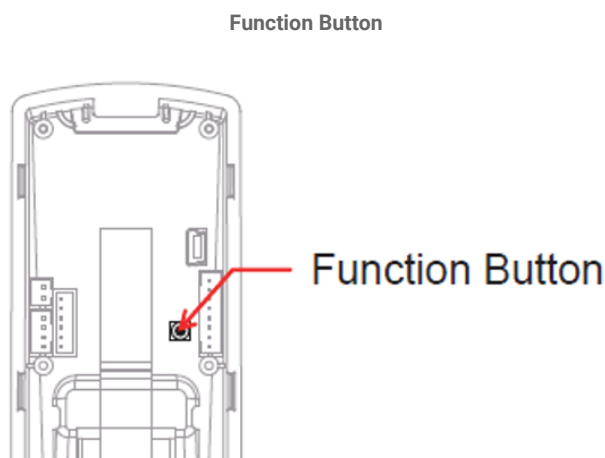

3.3. Registering a User

There are three ways to register a user: fingerprint, card, card+fingerprint.



See Section [Instructions for Placing Finger](#) about how to properly place your finger on the reader.

3.3.1. Registering a Fingerprint

Register a fingerprint.



For the enrollment procedure it is necessary to remove the finger from sensor after first enrollment and then put it on the sensor again for a second enrollment.

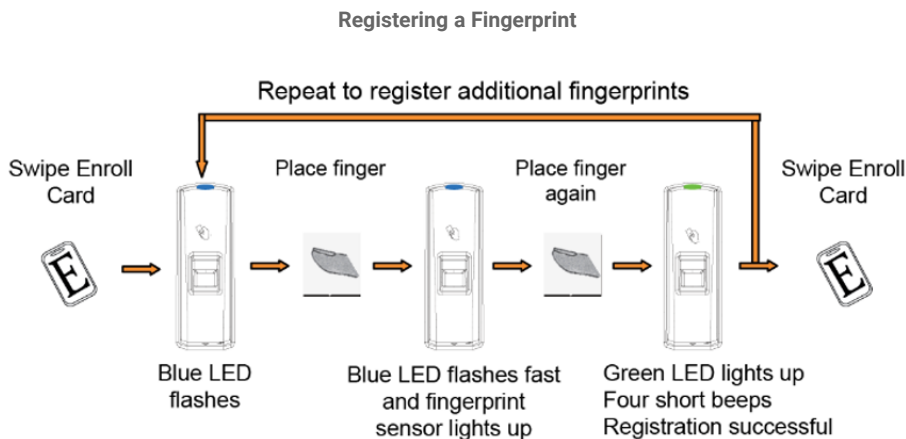

If the finger has been already registered, the red LED flashes and there are 2 long beeps.

3.3.2. Registering a Fingerprint and Card

Register a fingerprint and card.

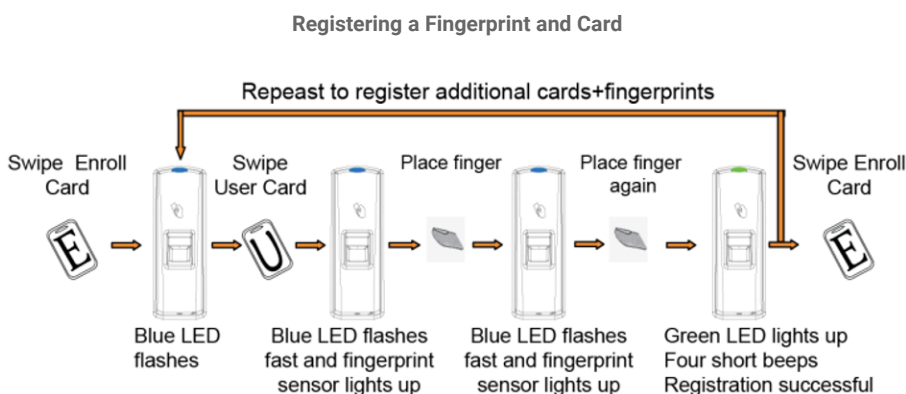

If the card and/or fingerprint have been already registered, the red LED flashes and there are 2 long beeps.

3.4. Deleting Users

3.4.1. Deleting a Fingerprint

Delete a fingerprint from the reader.

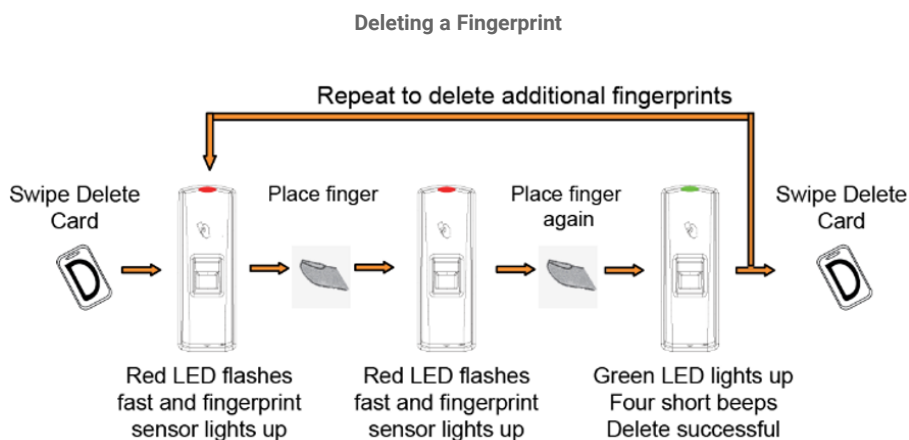

If the fingerprint does not exist in the system, the red LED flashes and there is a long beep.

3.4.2. Deleting a Card

Delete a fingerprint from the reader.

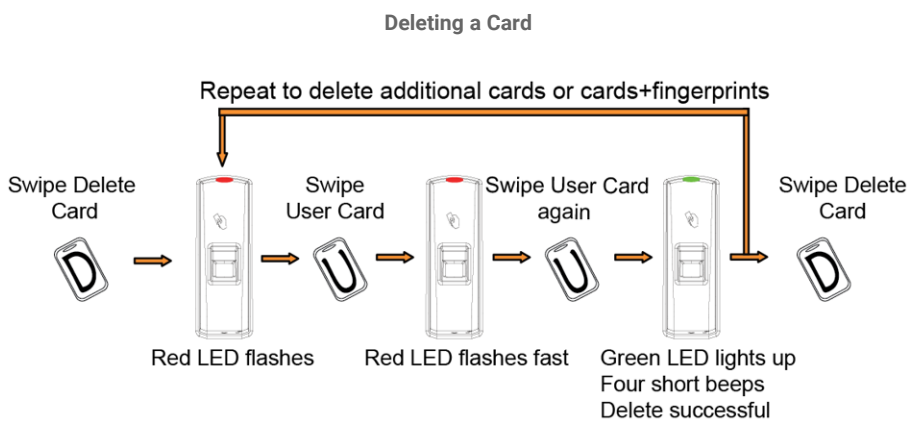

If the card does not exist in the system, the red LED flashes and there is a long beep.

4. Instructions for Placing Finger

4.1. Correct Method

Straighten your finger and then place it on the sensor, ensuring the finger is down flat and covers the entire sensor window.

Always place finger in the center of the sensor.

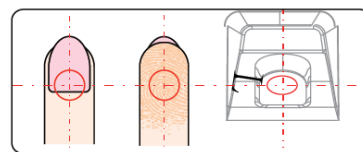

Make sure you cover the entire sensor surface with as much of your finger as possible.

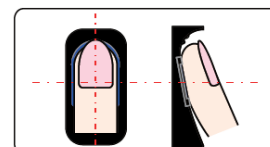

4.2. Incorrect Method

DO NOT move your finger before the back-lights of the sensor turns off.



DO NOT place finger away from the center of the sensor window.

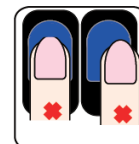

DO NOT place finger at an angle.

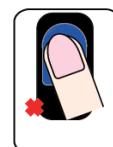

DO NOT take off finger during the fingerprint verification process.



DO NOT use just your fingertip.

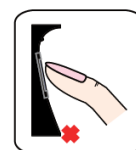

DO NOT slide your finger during the fingerprint verification process.



5. Technical Specifications

Fingerprint Sensor	500 DPI Optical Sensor
RFID Card Reader	AY-B8520 – 125 kHz AY-B8550 – 13.56 MHz
User Capacity	7000
Fingerprint Templates Capacity	7000 ¹
Card Capacity	7000
Log Capacity	100,000
Verification Speed	1000 templates: 1-2 sec (1:N) 1000 – 3000 templates: 2-4 sec (1:N)
Card Read Range	20 to 80 mm (0.8 to 3.1 in.)
Identification Mode	Fingerprint/Card
Network Port	TCP/IP
Wiegand Protocol	Wiegand 26-Bit
Voice and Interface	Multi-color LEDs and buzzer
Operating Voltage	12 VDC
Work Current	150 mA
Size (W x H x D)	55 x 145 x 37.5 mm (2.2 x 5.7 x 1.5 in.)
Certificate	FCC, CE, RoHS

Reader Layout

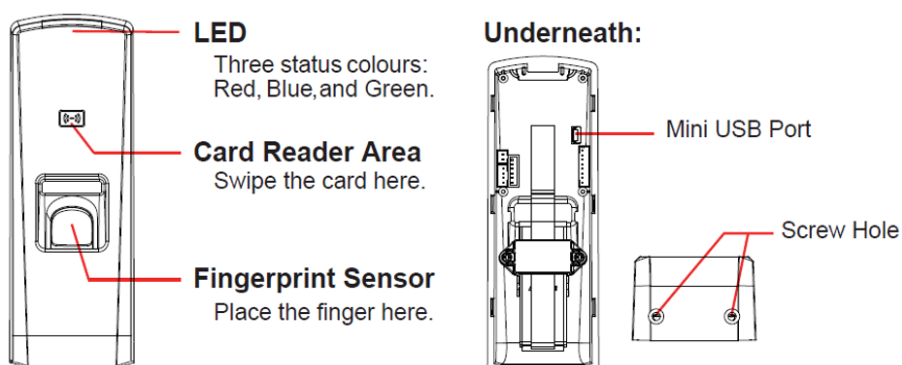

¹Loading more than 3000 templates is not recommended due to extended response time

6. Usage Notice

Do not scratch the surface of the optical fingerprint sensor with any sharp object such as a small knife or a pen.

- Humidity, dust, and direct light can affect the terminal's performance.
- Do not clean the surface of the optical fingerprint sensor with organic material such as alcohol or gasoline.
- To clean the surface, apply a piece of one-sided adhesive tape to the sensor and then remove.

7. Declaration of Conformity

FCC ID = GCD-B8520, GCD-B8550

This device complies with Part 15 of the FCC Rules. Operation is subject to the following two conditions:

- This device may not cause harmful interference.
- This device must accept any interference received, including interference that may cause undesired operation.

Changes or modifications not expressly approved by the party responsible for compliance could void the user's authority to operate the equipment.

This equipment has been tested and found to comply with the limits for a Class B digital device, pursuant to part 15 of the FCC Rules. These limits are designed to provide reasonable protection against harmful interference in a residential installation.

This equipment generates, uses, and can radiate radio frequency energy and, if not installed and used in accordance with the instructions, may cause harmful interference to radio communications. However, there is no guarantee that interference will not occur in a particular installation. If this equipment does cause harmful interference to radio or television reception, which can be determined by turning the equipment off and on, the user is encouraged to try to correct the interference by one or more of the following measures:

- Reorient or relocate the receiving antenna.
- Increase the separation between the equipment and receiver.
- Connect the equipment into an outlet on a circuit different from that to which the receiver is connected.
- Consult the dealer or an experienced radio/TV technician for help.

8. Radio Equipment Directive (RED)

Rosslare hereby declares that the AY-B85x0 are in compliance with essential requirements and other relevant provisions of Directive 2014/53/EU.

9. RoHS Directive

Under our sole responsibility that the following labeled AY-B85x0 is tested to conform to the Restriction of Hazardous Substances (RoHS) directive – 2011/65/EU – in electrical and electronic equipment.



• EN ISO 13485



All product names, logos, and brands are property of their respective owners.

DISCLAIMER: The data contained within Rosslare's materials or documentation is intended to provide only general information about products available for purchase from Rosslare Enterprises Ltd. and its associated companies ("Rosslare"). Reasonable efforts have been made to ensure the accuracy of this information. However, it might contain typographic errors, inaccuracies, or omissions that may relate to product descriptions, visual pictures, specifications, and other details. All technical specifications weights, measures and colors shown, are best approximations. Rosslare can not be held responsible and assumes no legal liability for the accuracy or completeness of the information provided. Rosslare reserves the right to change, delete, or otherwise modify the information, which is represented, at any time, without any prior notice.

© 2021 Rosslare Enterprises Ltd. All rights reserved.

For more information regarding support, visit <https://support.rosslaresecurity.com>.